











EWV1202YF

Features

-  Dual Output Frequencies
-  Push-push Architecture
-  Phase Noise: -107 dBc/Hz @ 100 kHz
-  Output Power at f_{out} : +10 dBm, typical
-  Output Power at $f_{out/2}$: +6 dBm, typical
-  Integrated Divide by 2 Prescaler
-  HBM Class 1A - ESD Protection Bias Circuitry
-  Package: 5 x 5 mm, 32 Lead, plastic overmold QFN
-  100% RF and DC tested
-  Also available in bare die format
-  RoHS Compliant

Device Photo

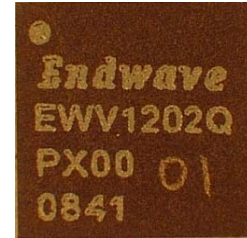

Description

The Endwave *EWV1202YF* is a high performance InGaP/GaAs HBT MMIC voltage controlled oscillator which provides a set of dual outputs ideal for applications which require 5.75 to 6.375 or 11.5 to 12.75 GHz outputs. The device boasts state of the art phase noise at better than -107 dBc/Hz at a 100 kHz offset. This device has integrated ESD Protection Bias Circuitry and can be used for a wide range of applications from defense electronics to commercial communication systems. All parts are 100% DC and RF tested and visually inspected to IPC-A-610.

Functional Diagram

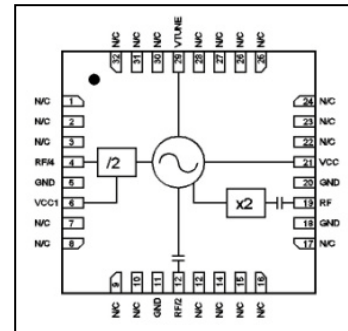

Electrical Characteristics (Temperature = +25 °C, $V_{dd}=+5$)

Parameter	Min.	Typ.	Max.	Units
Frequency Range (f_{out})	11.5		12.75	GHz
Frequency Range ($f_{out/2}$)	5.75		6.375	GHz
Output Power (f_{out})	+6	+10	+14	dBm
Output Power ($f_{out/2}$)	+4	+6	+12	dBm
Output Power ($f_{out/4}$)	-3	+1	+3	dBm
Phase Noise @ f_{out} 100 kHz Offset, $V_t = +5V$		-107		dBc/Hz
Tune Voltage	2		13	V
Supply Current				
VCO	230	260	290	mA
Prescaler (optional)	35	45	55	mA
Tune Port Leakage Current, $V_{tune} = 13V$			10	uA
Output Return Loss		5		dB
Harmonic / Subharmonics				
$\frac{1}{2}$		25		dBc
2^{nd}		9		dBc
Pulling (into a 2:1 VSWR)		10		MHz pp
Pushing @ $V_{tune} = 5V$		15		MHz/V
Frequency Drift Rate			-1.0	MHz/ C

RF Frequency vs. Tuning Voltage, $V_{cc} = 5V$

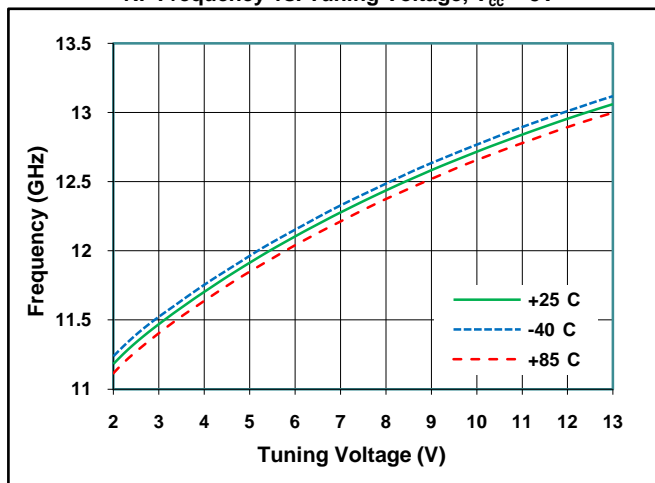

RF Sensitivity vs. Tuning Voltage, $V_{cc} = 5V$

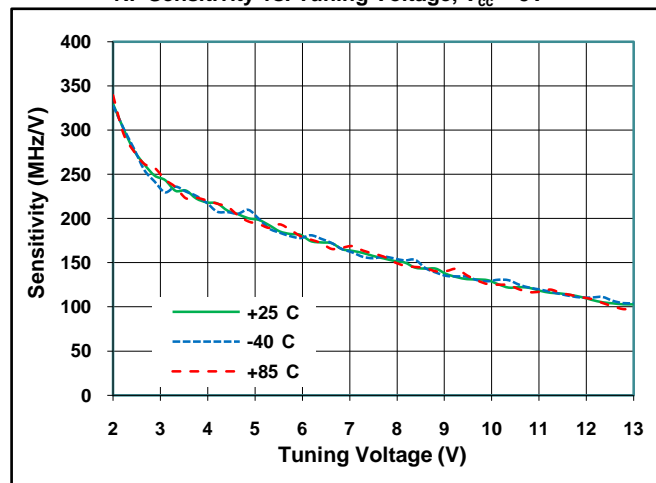

RF Output Power vs. Tuning Voltage, $V_{cc} = 5V$

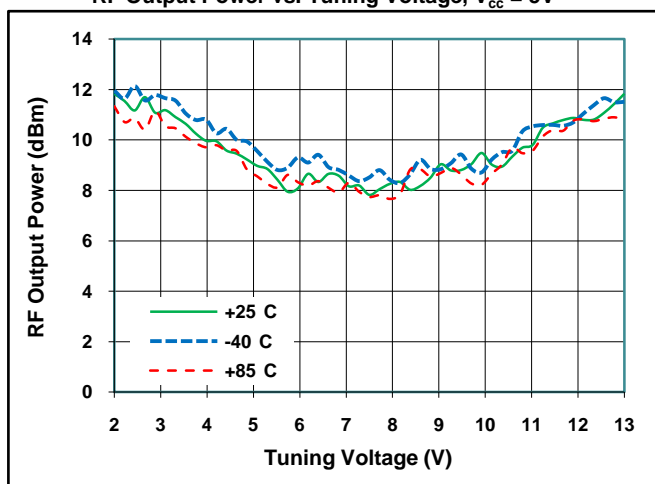

RF/2 Output Power vs. Tuning Voltage, $V_{cc} = 5V$

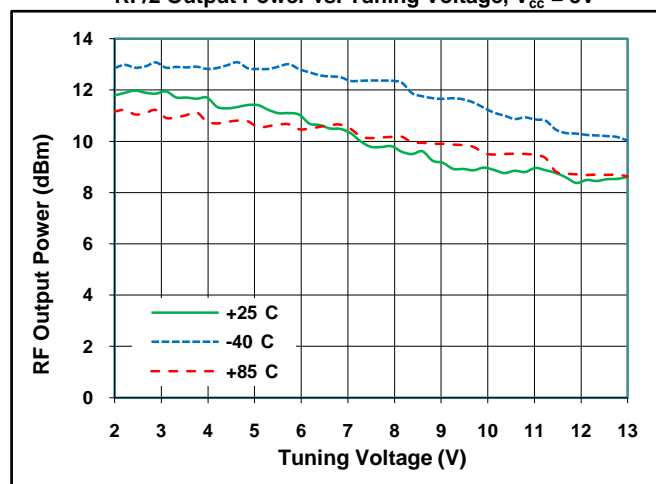

SSB Phase Noise @ RF Output vs. Tuning Voltage

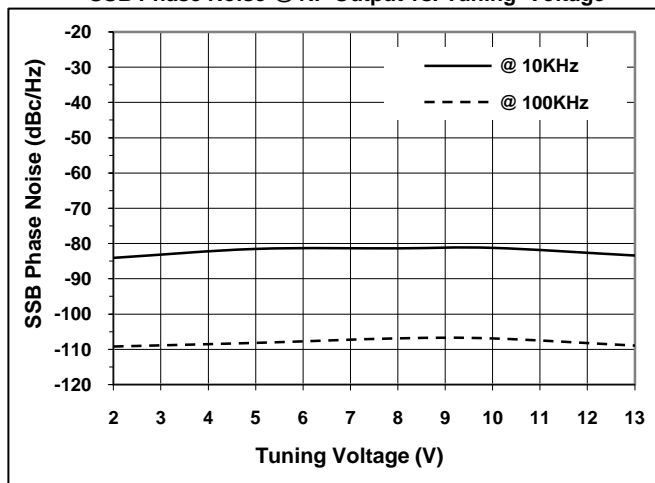

SSB Phase Noise @ RF Output / $V_{tune} = 8V$

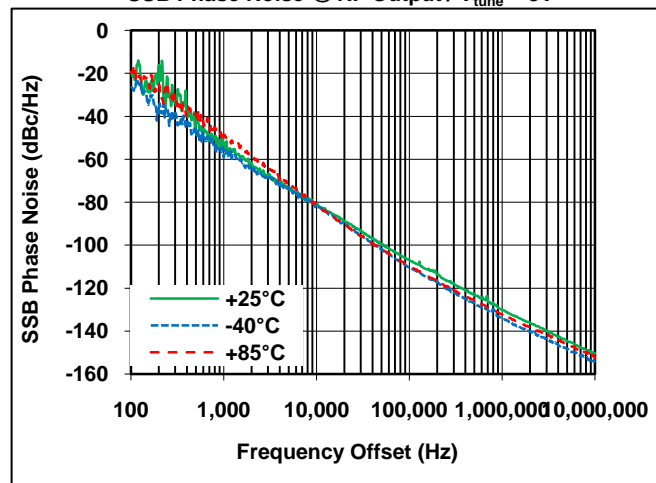

DC & RF Pinout

Pin Number	Function
1-3, 7-10, 13-17, 22-28, 30-32	No Connection
5, 11, 18, 20	Ground (or no connection)
19	RF Output (f_{out})
12	RF/2 Output ($f_{out/2}$) ^{Note 1}
4	RF/4 Output ($f_{out/4}$) ^{Note 2}
6	V_{cc1} for Prescaler
21	V_{cc} for VCO
29	V_{tune}

Note 1 It is recommended that RF/2 Output be terminated with a 50 ohm load if not used.

Note 2 DC block must be used at RF/4 output port. 100pf 0402 capacitor is used on ENWV eval boards.

Outline Drawings

“F” Package – 5 x 5mm, 32 lead

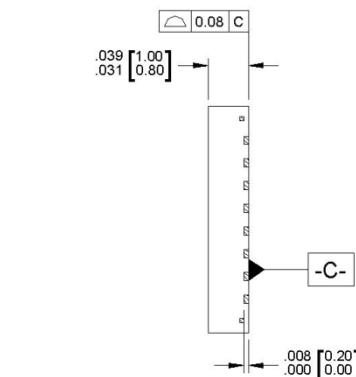
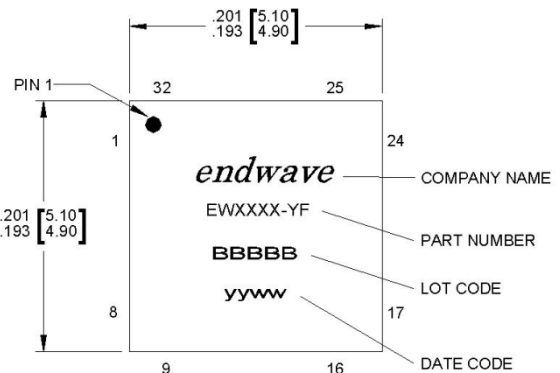
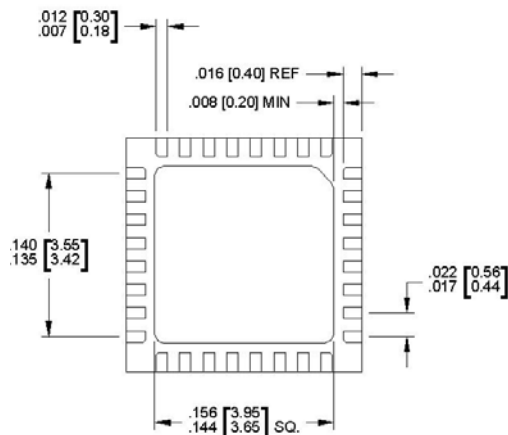

 Electrostatic Sensitive Device
Observe Handling Precautions

Notes:

1. Lead frame material is a copper alloy.
2. Dimensions are in inches (mm).
3. Min and max dimensions indicated.
4. Ground paddle must be soldered to ground. Damage will result if not properly connected.

Absolute Maximum Ratings

Supply Voltage, V_{cc}	+5.5V
Tune Voltage, V_t	+0 to +15 V
Channel Temperature	135°C
Continuous Power Dissipation at 25°C	1.32 W
Supply Current, VCO	330 mA
Supply Current, Prescaler	60 mA
Storage Temperature	-65 to +150°C
Operating Temperature	-40 to +85°C

Typical Supply Current

V_{cc}	I_{cc}
4.8 V	237 mA
5.0 V	260mA
5.2 V	284 mA

Typical Application

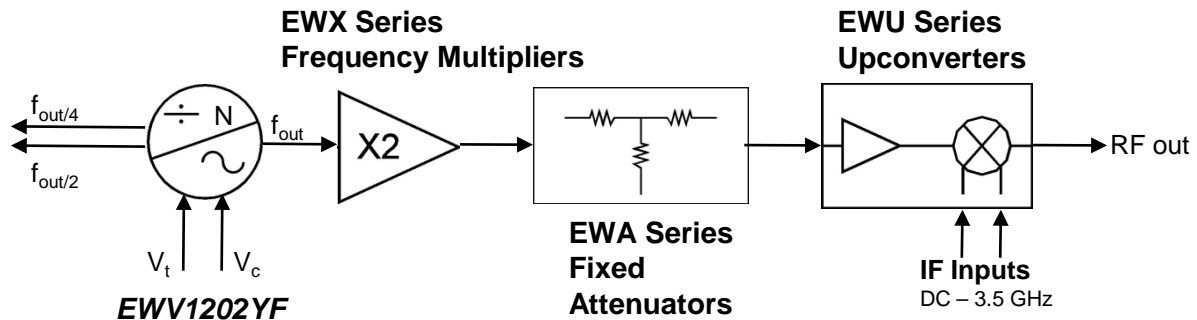

Support Documentation

Support documentation including Assembly Notes, Application Notes and Qualification Procedures can be found on our website at www.endwave.com.

Ordering Information

Part Number	Description
EWV1202YF	RoHS compliant 5 x 5mm, 32 lead, QFN "F" Package
EWV1202YF-EV	EWV1202YF on an Evaluation Board
EWV1202ZZ	RoHS compliant bare die in waffle or gel packs
EWV1202ZZ-EV	EWV1202ZZ in a connectorized test fixture